

Features

Supports the Hamamatsu S13361-6050AE-04
4x4 array of 6mm SiPMs

Horizontal signal connector located on the front,
array located on the front

3-side tileable installation

Four encoded position signals for event centroid
calculations: X+, X-, Y+, Y-

DC-coupled signal path

Low power consumption

Patented diode-coupled charge division readout,
superior to traditional resistive readout

Improved spatial uniformity

Faster rise time

Reduced image noise

Precision temperature sensor

Mounting hole for #2 hardware

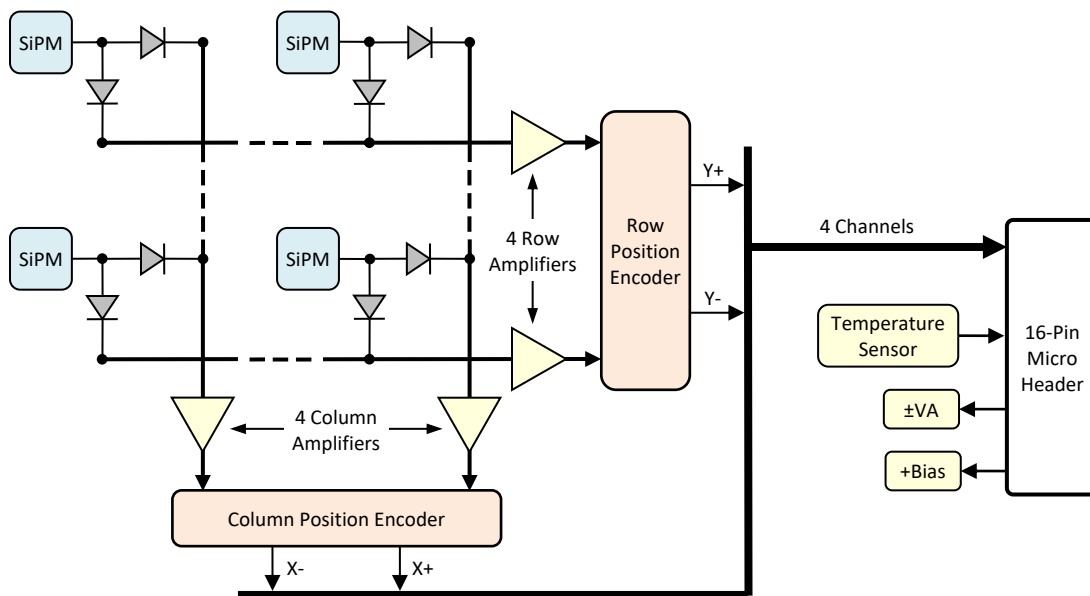
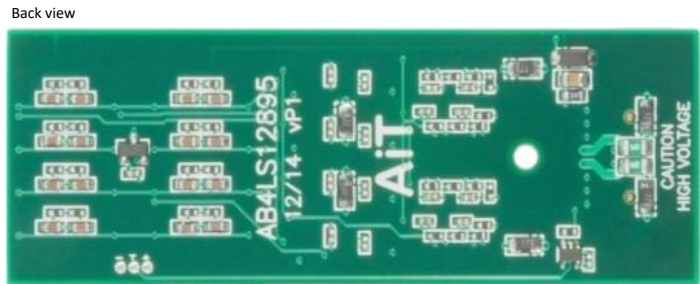
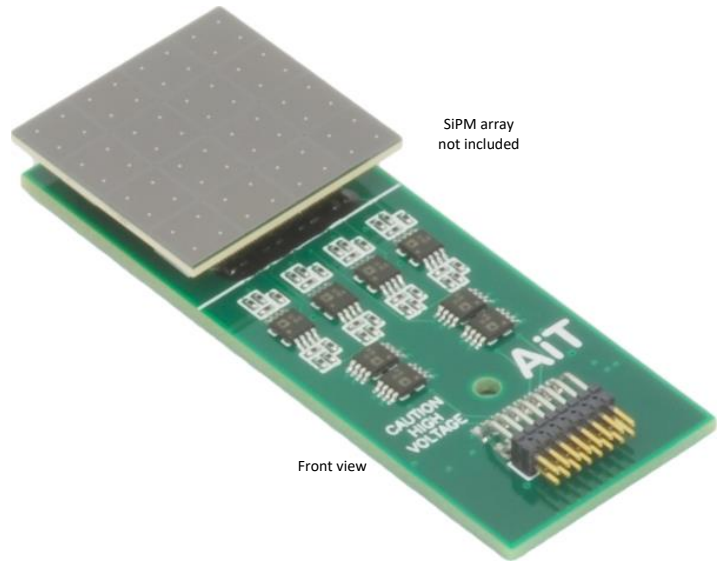

Specifications

Position Signal Outputs

Encoding	Charge division multiplexed to 4 output channels: X+, X-, Y+, Y-
Gain	750Ω transimpedance gain
Output voltage	0 → -1V into 100Ω load
Output impedance	100Ω
Output current	50mA maximum

Temperature Sensor

Output voltage	500mV + 10mV per °C
Output current	10mA
Output impedance	100Ω
Accuracy	±0.5°C

Bias Voltage

Voltage clamp	+56V typical (refer to SiPM data) 68V Zener diode 375mW maximum
---------------	---

Amplifier Voltage (±VA)

Current	±2.8V → ±5.5V maximum ±30mA typical (I _q , no signal, no load)
---------	---

Signal Connector

Mating assembly	Horizontal 16-pin 2-row header 0.050" pin pitch Samtec FFSD-08-D-XX.XX-01-N (XX.XX = length in inches)
-----------------	---

Channel Map

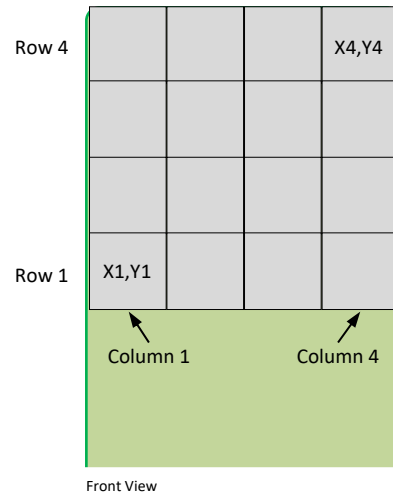

Front View

Signal Connector

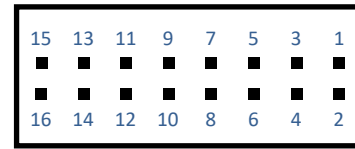

PCB Side View

Pin	Function	Pin	Function
1	Temperature	2	Ground
3	X-	4	Ground
5	X+	6	Ground
7	-VA	8	Ground
9	+VA	10	Ground
11	Y-	12	Ground
13	Y+	14	Ground
15	+Bias	16	Ground

4-Channel Position Encoder

Row & Column Encoder Weights

Row# or Col# (for X- or Y-)	Row# or Col# (for X+ or Y+)	Fraction (ideal)	Fraction (actual)	% Error	Notes
1	4	0.2500	0.2483	-0.68 %	Sum of X- and X+ fractions or Y- and Y+ fractions = 1.2500 Independent of signal position
2	3	0.5000	0.5000	0.00 %	
3	2	0.7500	0.7500	0.00 %	
4	1	1.0000	1.0000	0.00 %	

Note: Errors exclude component tolerances

Output Signals

$$X- = (\text{SiPM signal}) * (\text{encoder gain}) * (X- \text{ fraction})$$

$$X+ = (\text{SiPM signal}) * (\text{encoder gain}) * (X+ \text{ fraction})$$

$$Y- = (\text{SiPM signal}) * (\text{encoder gain}) * (Y- \text{ fraction})$$

$$Y+ = (\text{SiPM signal}) * (\text{encoder gain}) * (Y+ \text{ fraction})$$

Typical event position calculation:

$$\text{X column} = (X+ - X-) / (X+ + X-)$$

$$\text{Y row} = (Y+ - Y-) / (Y+ + Y-)$$

Example

SiPM signal at column 4, row 2 (excluding encoder gain)

$$X- = (\text{Column 4 signal}) * 1.0000$$

$$X+ = (\text{Column 4 signal}) * 0.2483$$

$$Y- = (\text{Row 2 signal}) * 0.5000$$

$$Y+ = (\text{Row 2 signal}) * 0.7500$$

Typical Signals

Source = Laser; Receiver = ABR4, one channel, minimum gain; Bias = +55V; FFSD cable = 36"

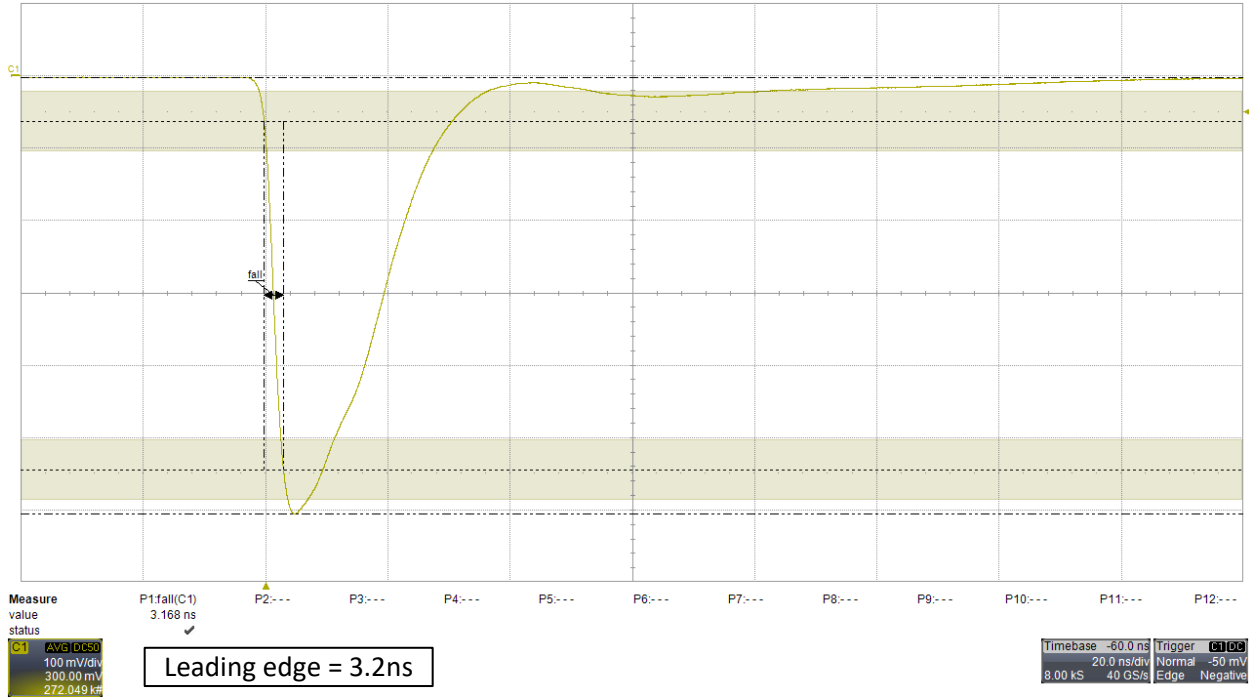

Source = LYSO emission; Receiver = ABR4, channel 1, minimum gain; Bias = +55V; FFSD cable = 36"; persistence display

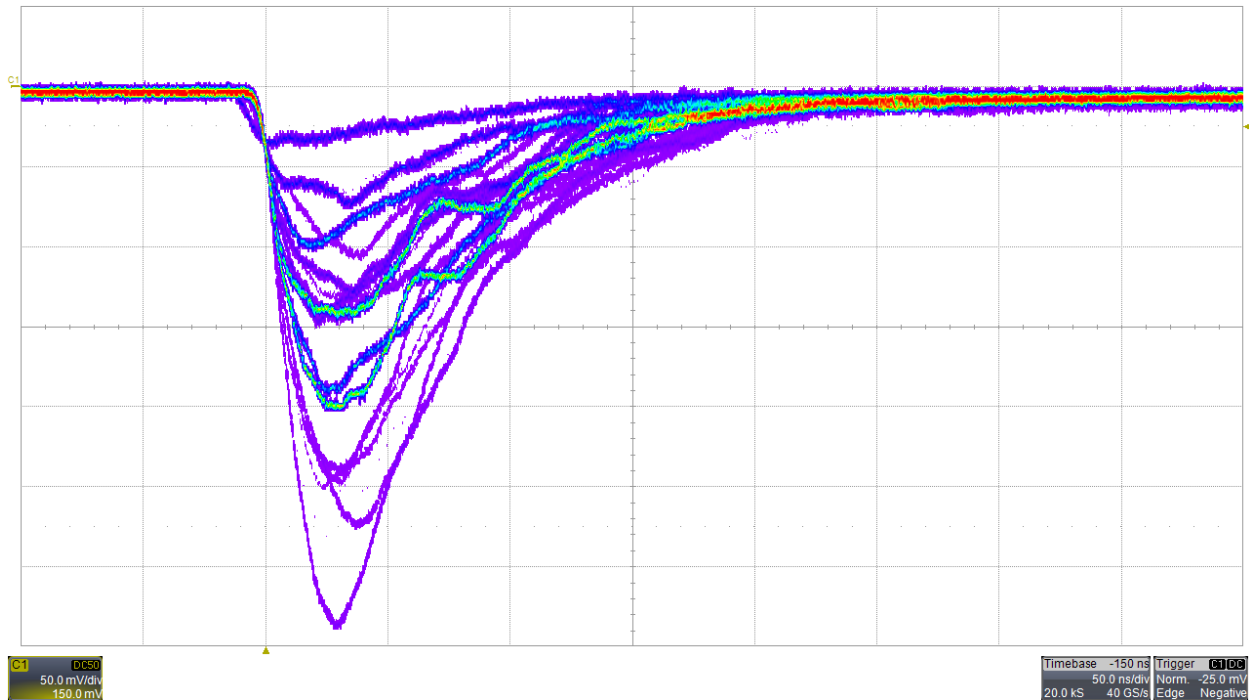

Mechanical

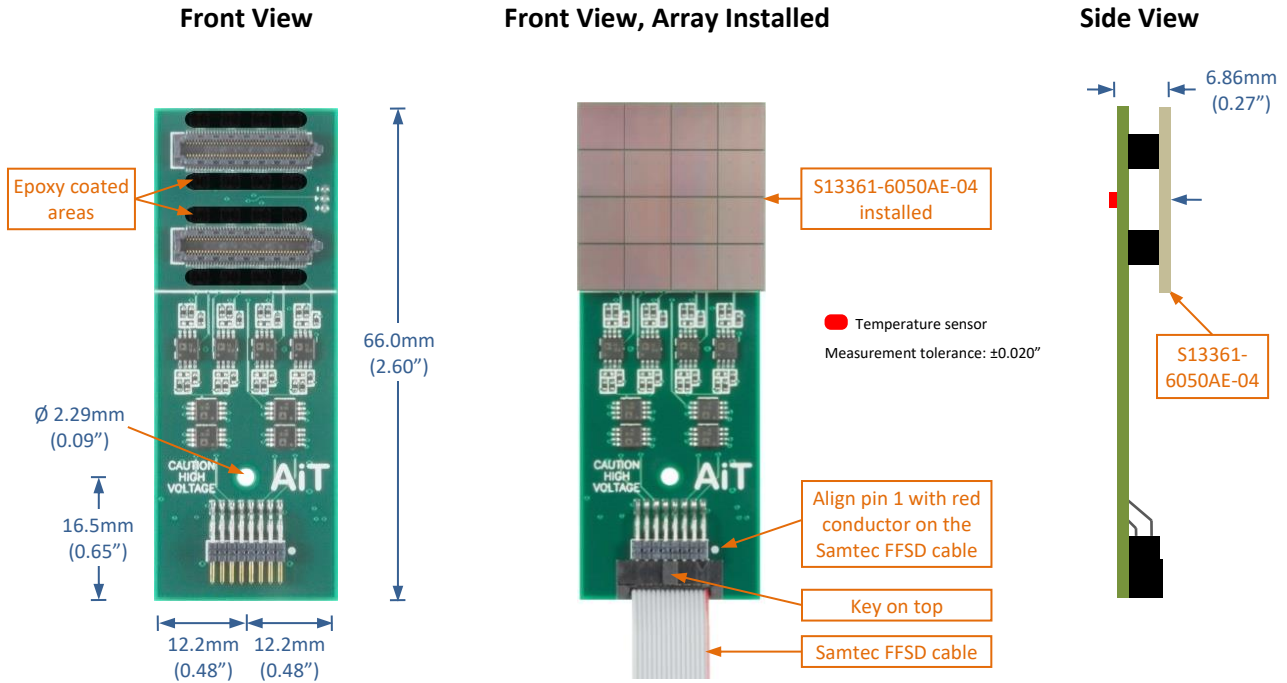

4-Channel Active Base Readout Kit

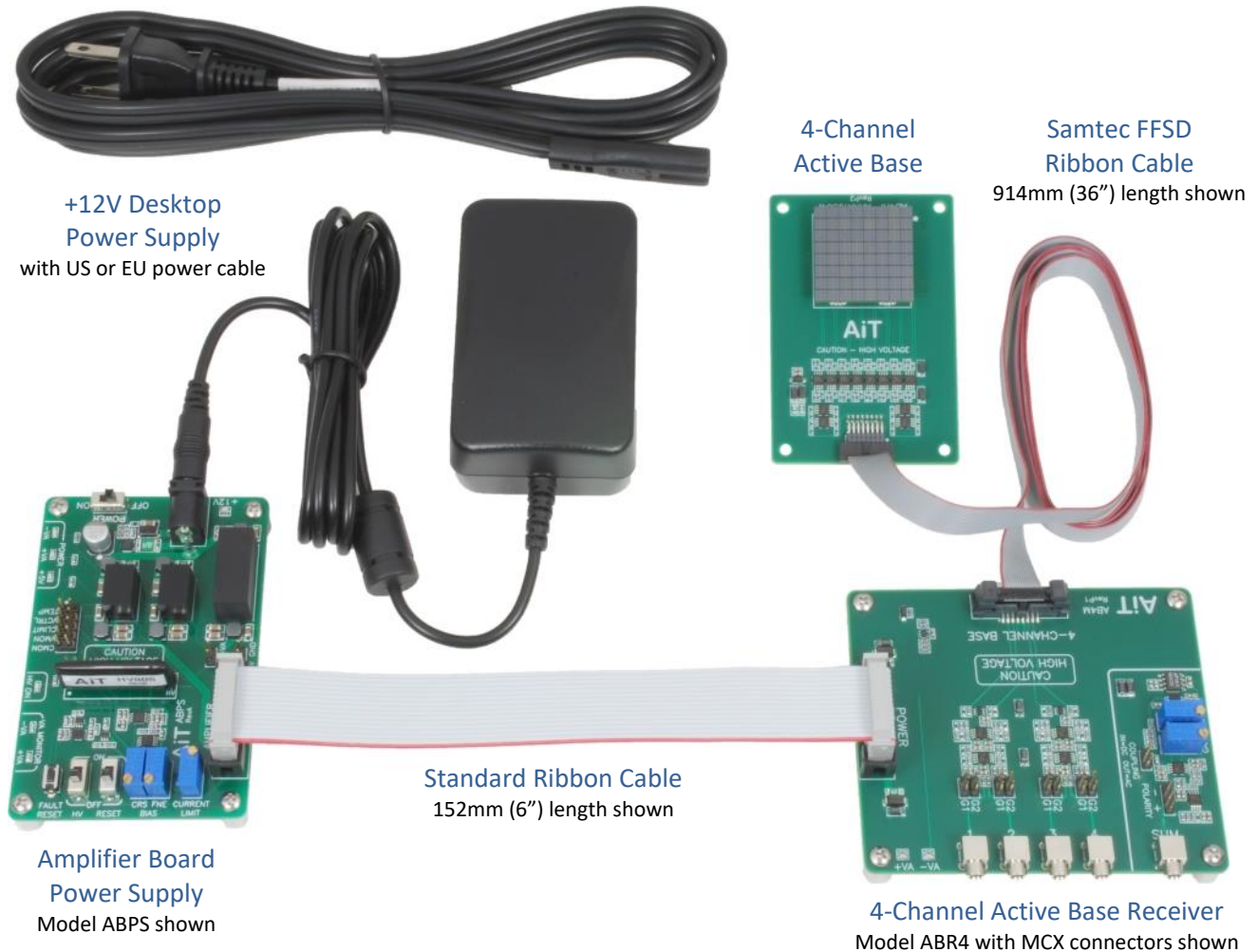

+12V Desktop Power Supply with US or EU power cable

4-Channel Active Base

Samtec FFSD Ribbon Cable 914mm (36") length shown

Standard Ribbon Cable 152mm (6") length shown

Amplifier Board Power Supply Model ABPS shown

4-Channel Active Base Receiver Model ABR4 with MCX connectors shown

Components

Each component is available separately. Refer to each datasheet for details.

The Active Base includes a 914mm (36") Samtec FFSD micro-pitch ribbon cable.

The Amplifier Board Power Supply includes a 12V desktop power supply and a HV80 bias voltage power supply.

The 4-channel Active Base Receiver includes a 152mm (6") power supply ribbon cable and a breakout board to connect any external power supply.

Safety Information



WARNING – High Voltage

- High voltage may be present during operation
- High voltage stored on capacitors may be present after power is removed
- Improper handling may result in personnel injury or equipment damage

This high-voltage device must be used only by personnel trained and qualified in safe handling, installation, and operation of high-voltage equipment.



CAUTION – Electrostatic Discharge (ESD) Sensitivity

The circuit board can be damaged by electrostatic discharge. Observe precautions for handling electrostatic sensitive devices. Handle only at static-safe workstations.

High-Gain Photodetectors

High-gain photodetectors such as silicon photomultipliers may conduct damaging currents if exposed to high optical signal levels while the bias voltage is applied, or if the bias voltage exceeds the recommended operating range. These devices must be operated only in low-light conditions, and only within the manufacturer's recommended bias voltage range.

Handling and Disassembly

This product may be provided with a protective enclosure. Disassembled enclosure components and circuit boards may contain sharp edges. Take appropriate safety precautions while assembling or disassembling the enclosure and handling disassembled components.

Indoor Use Only

Do not operate this product in a wet or damp environment. Do not operate in an explosive atmosphere.

Use of this product, and AiT Instruments' liability related to use of this product, is further governed by AiT Instruments' standard terms and conditions of sale, which were provided upon purchase of this product.